



# **Intel<sup>®</sup> Platform Panel PC**

## **USER'S MANUAL**

Version 1.4

## Content

FCC Statement .....	6
Copyright Notice .....	6
Trademark Acknowledgement.....	6
Disclaimer.....	6
Safety Precautions .....	7
Packing List.....	7
Winmate Customer Service.....	7
Safety and Warranty .....	8
Chapter 1 General Information.....	9
1.1 Product Overview .....	10
1.2 Features .....	10
1.3 System Specification.....	11
1.4 LCD Specification .....	12
1.5 Mechanical Drawing.....	14
1.6 Input / Output Devices .....	15
Chapter 2 Hardware Installation .....	17
2.1 DVD ROM Installation.....	17
2.2 HDD Installation .....	18
Chapter 3 Settings Jumpers and Connectors.....	21
3.1 Jumpers and Connectors .....	21
3.1.1 Jumper and Connector Layout .....	21
3.1.2 Jumpers and Connectors .....	22
3.2 Setting Jumpers .....	24
3.2.1 CPU Host Clock(JP1).....	24
3.2.2 Power Mode Setting(JP2).....	24
3.2.3 LVDS Power Setting(JP3).....	24
3.2.4 1394 Controller EEPROM Write Protect(JP4).....	24
3.2.5 RS232/422/485 (COM2) Selection(JP6, JP7, JP8).....	25
3.2.6 COM2 RS232 Pin9 Setting(JP9) .....	25
3.2.7 COM1 RS232 Pin9 Setting(JP10).....	25
3.2.8 Clear CMOS Contents(JP11) .....	26
3.2.9 Compact Flash Mode Setting(JP13).....	26
3.2.10 Intel® 82541GI Gigabit LAN Enable/Disable(J13) .....	26
3.3 Connector Definitions.....	27
3.3.1 DC Jack for DC Adaptor (CN1).....	27
3.3.2 PS/2 Keyboard and PS/2 Mouse Connectors (CN2) .....	27

3.3.3	DVI-I Connector (CN3).....	27
3.3.4	Parallel Port Connector (CN4).....	28
3.3.5	RJ45 and 2 USB Ports (CN6).....	28
3.3.6	COM1 and COM2 Serial Ports (CN7).....	28
3.3.7	HDD Power Connector (J2).....	29
3.3.8	Internal DC-In Power Connector (J3).....	29
3.3.9	LCD Backlight Setting (J5).....	29
3.3.10	Panel Connectors (1st channel, 2nd channel) (J6, J8).....	29
3.3.11	IrDA Connector (J7).....	30
3.3.12	Digital I/O (J10).....	30
3.3.13	USB Port Pin Header (J11, J12).....	30
3.3.14	HDD Power Pin Header (J16).....	30
3.3.15	Mini PCI Socket (J17).....	30
3.3.16	Primary and Secondary IDE Connectors (J18, J19).....	31
3.3.17	Secondary IDE Connector (J19).....	31
3.3.18	CD-In Pin Header (J20).....	32
3.3.19	External Audio Connector (J21).....	32
3.3.20	System Function Connector (J22).....	32
3.3.21	Wake On LAN Connector (J23).....	33
3.3.22	Compact Flash Socket (J24).....	34
3.3.23	VGA CRT Connector (J25).....	34
3.3.24	CPU Fan Power Connector (FAN1).....	34
3.3.25	System Fan Power Connector (FAN2).....	34
Chapter 4 AWARD BIOS Setup.....		36
4.1	Starting Setup.....	36
4.2	Using Setup.....	37
4.2.1	Navigating Through The Menu Bar.....	37
4.2.2	To Display a Sub Menu.....	37
4.3	Getting Help.....	38
4.4	In Case of Problems.....	38
4.5	Main Menu.....	38
4.5.1	Standard CMOS Features.....	39
4.5.1.1	Main Menu Selection.....	40
4.5.1.2	IDE Adapters.....	41
4.5.2	Advanced BIOS Features.....	42
4.5.2.1	CPU Feature.....	42
4.5.2.2	Virus Warning.....	42
4.5.2.3	CPU L1 and L2 Cache / CPU L3 Cache.....	42
4.5.2.4	Quick Power On Self Test.....	43

4.5.2.5	First/Second/Third Boot Device.....	43
4.5.2.6	Boot Other Device .....	43
4.5.2.7	Swap Floppy Drive .....	43
4.5.2.8	Boot Up Floppy Seek .....	43
4.5.2.9	Boot Up NumLock Status .....	43
4.5.2.10	Gate A20 Option .....	43
4.5.2.11	Typematic Rate Setting.....	43
4.5.2.12	Typematic Rate (Chars/Sec) .....	43
4.5.2.13	Typematic Delay (Msec).....	44
4.5.2.14	Security Option .....	44
4.5.2.15	APIC Mode .....	44
4.5.2.16	MPS Version Control for OS.....	44
4.5.2.17	OS Select for DRAM > 64MB.....	44
4.5.2.18	Report No FDD For WIN 95 .....	44
4.5.2.19	Small Logo (EPA) Show .....	44
4.5.3	Advanced Chipset Features.....	45
4.5.3.1	DRAM Timing Selectable .....	45
4.5.3.2	CAS Latency Time.....	45
4.5.3.3	Active to Precharge Delay .....	45
4.5.3.4	DRAM RAS# to CAS# Delay .....	45
4.5.3.5	DRAM RAS# Precharge.....	46
4.5.3.6	DRAM Data Integrity Mode.....	46
4.5.3.7	MGM Core Frequency .....	46
4.5.3.8	System BIOS Cacheable .....	46
4.5.3.9	Video BIOS Cacheable.....	46
4.5.3.10	Memory Hole At 15M-16M .....	46
4.5.3.11	Delayed Transaction .....	46
4.5.3.12	Delay Prior to Thermal.....	46
4.5.3.13	AGP Aperture Size .....	47
4.5.3.14	On-Chip VGA .....	47
4.5.3.15	On-Chip Frame Buffer Size .....	47
4.5.3.16	Boot Display .....	47
4.5.3.17	TV Standard .....	47
4.5.3.18	Video Connector.....	47
4.5.3.19	TV Format.....	47
4.5.3.20	Panel Scaling.....	47
4.5.3.21	Panel Number .....	47
4.5.3.22	Panel Protocol .....	48
4.5.4	Integrated Peripherals.....	48
4.5.4.1	OnChip Primary/Secondary PCI IDE.....	49

4.5.4.2	IDE Primary/Secondary Master/Slave PIO.....	49
4.5.4.3	IDE Primary/Secondary Master/Slave UDMA.....	49
4.5.4.4	IDE HDD Block Mode .....	50
4.5.4.5	USB Controller .....	50
4.5.4.6	USB 2.0 Controller .....	50
4.5.4.7	USB Keyboard Support .....	50
4.5.4.8	USB Mouse Support .....	50
4.5.4.9	AC97 Audio .....	50
4.5.4.10	Init Display First.....	50
4.5.4.11	Power On After Fail .....	50
4.5.4.12	Onboard FDC Controller .....	50
4.5.4.13	Onboard Serial/Parallel Port.....	51
4.5.4.14	UART Mode Select .....	51
4.5.4.15	Parallel Port Mode.....	51
4.5.5	Power Management Setup.....	51
4.5.5.1	Power Supply Type .....	52
4.5.5.2	ACPI Function.....	52
4.5.5.3	Power Management.....	52
4.5.5.4	Video Off Method.....	52
4.5.5.5	Video Off In Suspend.....	53
4.5.5.6	Suspend Type .....	53
4.5.5.7	Modem Use IRQ.....	53
4.5.5.8	Suspend Mode.....	53
4.5.5.9	HDD Power Down .....	53
4.5.5.10	Soft-Off by PWRBTN.....	53
4.5.5.11	CPU THRM-Throttling.....	53
4.5.5.12	Wake up by PCI Card.....	53
4.5.7.1	CPU Warning Temperature.....	55
4.5.7.2	Temperatures/Voltages.....	55
4.5.7.3	Shutdown Temperature .....	55
4.5.7.4	Smart Fan Temperature .....	55
4.5.8	Frequency/Voltage Control.....	56
4.5.8.1	Auto Detect PCI Clk.....	56
4.5.8.2	Spread Spectrum Modulated .....	56
4.5.9	Load Fail-Safe Defaults .....	56
4.5.10	Load Optimized Defaults .....	56
4.5.11	Set Supervisor Password .....	56
4.5.12	Save & Exit Setup .....	57
4.5.13	Exit Without Saving .....	57

Chapter 5	Driver Installation .....	59
5.1	Intel Chipset Software Installation Utility .....	59
5.2	VGA Drivers Installation.....	61
5.3	AC97 Codec Audio Driver Installation .....	62
5.4	Intel PRO LAN Drivers Installation.....	63
Chapter 6	Touch Screen .....	64
6.1	Introduction .....	65
6.2	The Elo AccuTouch Driver Installation.....	65
6.2.1	Configuration Utility .....	66
6.3	The Premier Touch Driver Installation .....	68
6.3.1	Configuration Utility .....	69

## **FCC Statement**

**FC** THIS DEVICE COMPLIES WITH PART 15 FCC RULES. OPERATION IS SUBJECT TO THE FOLLOWING TWO CONDITIONS:

- (1) THIS DEVICE MAY NOT CAUSE HARMFUL INTERFERENCE.
- (2) THIS DEVICE MUST ACCEPT ANY INTERFERENCE RECEIVED INCLUDING INTERFERENCE THAT MAY CAUSE UNDESIRE PERATION.

THIS EQUIPMENT HAS BEEN TESTED AND FOUND TO COMPLY WITH THE LIMITS FOR A CLASS "A" DIGITAL DEVICE, PURSUANT TO PART 15 OF THE FCC RULES. THESE LIMITS ARE DESIGNED TO PROVIDE REASONABLE PROTECTION AGAINST HARMFUL INTERFERENCE WHEN THE EQUIPMENT IS OPERATED IN A COMMERCIAL ENVIRONMENT. THIS EQUIPMENT GENERATES, USES, AND CAN RADIATE RADIO FREQUENCY ENERGY AND, IF NOT INSTALLED AND USED IN ACCORDANCE WITH THE INSTRUCTION MANUAL, MAY CAUSE HARMFUL INTERFERENCE TO RADIO COMMUNICATIONS. OPERATION OF THIS EQUIPMENT IN A RESIDENTIAL AREA IS LIKELY TO CAUSE HARMFUL INTERFERENCE IN WHICH CASE THE USER WILL BE REQUIRED TO CORRECT THE INTERFERENCE AT HIS OWN EXPENSE.

## **Copyright Notice**

Copyright © 2006 Winmate Technology Inc., ALL RIGHTS RESERVED.

No part of this document may be reproduced, copied, translated, or transmitted in any form or by any means, electronic or mechanical, for any purpose, without the prior written permission of the original manufacturer.

Trademark Acknowledgement

Brand and product names are trademarks or registered trademarks of their respective owners.

## **Disclaimer**

Winmate Communication Inc. reserves the right to make changes, without notice, to any product, including circuits and/or software described or contained in this manual in order to improve design and/or performance. Winmate Communication assumes no responsibility or liability for the use of the described product(s), conveys no license or title under any patent, copyright, or mask work rights to these products, and makes no representations or warranties that these products are free from patent, copyright, or mask work right infringement, unless otherwise specified. Applications that are described in this manual are for illustration purposes only. Winmate Communication Inc. makes no representation or warranty that such application will be suitable for the specified use without further testing or modification.

## **Safety Precautions**

### ◆ Warning!



Always completely disconnect the power cord from your chassis whenever you work with the hardware. Do not make connections while the power is on. Sensitive electronic components can be damaged by sudden power surges. Only experienced electronics personnel should open the PC chassis.

### ◆ Caution!



Always ground yourself to remove any static charge before touching the CPU card. Modern electronic devices are very sensitive to static electric charges. As a safety precaution, use a grounding wrist strap at all times.

Place all electronic components in a static-dissipative surface or static-shielded bag when they are not in the chassis.

## **Packing List**

Before using this Panel PC, please make sure that all the items listed below are present in your package :

- Panel PC
- User's manual
- Power adapter
- Power cord
- Driver CD-ROM disc

If any of these items are missing or damaged, contact your distributor or sales representative immediately.

## **Winmate Customer Service**

Winmate provide service guide for any problem as follow steps : First, visit the Winmate web site at [www.winmate.com](http://www.winmate.com) to find the update information about the product. Second, contact with your distributor, sales representative, or Winmate's customer service center for technical support if you need additional assistance. You may have the following information ready before you call :

- Product serial number
- Peripheral attachments
- Software (OS, version, application software, etc.)
- Description of complete problem
- The exact wording of any error messages

In addition, free technical support is available from Winmate's engineers every business day. We are always ready to give advice on application requirements or specific information on the installation and operation of any of our products. Please do not hesitate to call or e-mail us.



## **Safety and Warranty**

1. Please read these safety instructions carefully.
2. Keep this user's manual for later reference.
3. Disconnect this equipment from any AC outlet before cleaning. Do not use liquid or spray detergents for cleaning. Use a damp cloth.
4. For pluggable equipment, the power outlet must be installed near the equipment and must be easily accessible.
5. Keep this equipment away from humidity.
6. Put this equipment on a reliable surface during installation. Dropping it or letting it fall could cause damage.
7. The openings on the enclosure are for air convection. Protect the equipment from overheating. **DO NOT COVER THE OPENINGS.**
8. Make sure the voltage of the power source is correct before connecting the equipment to the power outlet.
9. Position the power cord so that people cannot step on it. Do not place anything over the power cord.
10. All cautions and warnings on the equipment should be noted.
11. If the equipment is not used for a long time, disconnect it from the power source to avoid damage by transient over-voltage.
12. Never pour any liquid into an opening. This could cause fire or electrical shock.
13. Never open the equipment. For safety reasons, only qualified service personnel should open the equipment.
14. If any of the following situations arises, get the equipment checked by service personnel:
  - a. The power cord or plug is damaged.
  - b. Liquid has penetrated into the equipment.
  - c. The equipment has been exposed to moisture.
  - d. The equipment does not work well, or you cannot get it to work according to the users manual.
  - e. The equipment has been dropped and damaged.
  - f. The equipment has obvious signs of breakage.
15. **DO NOT LEAVE THIS EQUIPMENT IN AN UNCONTROLLED ENVIRONMENT WHERE THE STORAGE TEMPERATURE IS BELOW -20° C (-4°F) OR ABOVE 60° C (140° F). IT MAY DAMAGE THE EQUIPMENT.**

# CAPTER 1

## General Information

This chapter gives background information to the Panel PC.

Sections include:

- Product Overview
- Features
- System Specification
- LCD Specification
- Mechanical Dimensions
- Input / Output Devices

The product is a high performance Panel PC with Intel 855GME chipset motherboard and combine with a TFT LCD Panel. It is a compact design to meet the demanding performance requirements of today's business and industrial applications.

## 1.1 Product Overview

Panel PC combines a motherboard, LCD Display within a compact chassis, with an option to add on HDD, FDD, CD-ROM, and touch screen as a matter of preference.

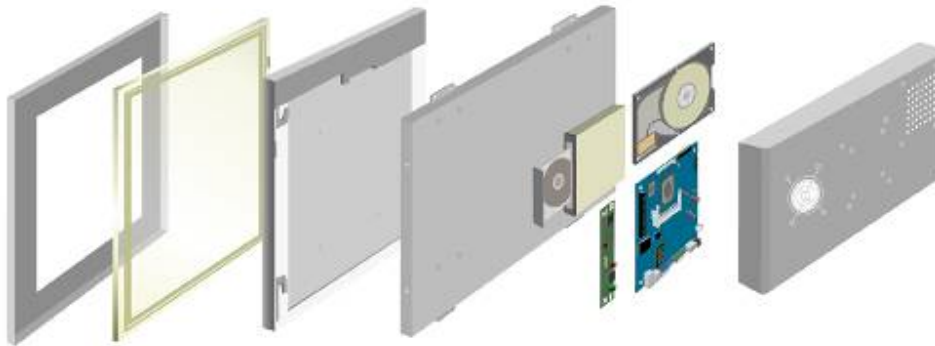

## 1.2 Features

### CPU Onboard:

The PPC is designed for Intel® Pentium® / Celeron® M CPU onboard, which is equipped with a high performance and low power processor, an advanced multi-I/O, provides all the performance, reliability, and quality.

### LCD Display:

The PPC is equipped with a TFT LCD size from 8.4" to 42".

### Power Management :

The PPC supports DC input power supply with a power adapter. Supports AC97, LAN wake up and modem ring-in functions. I/O peripheral devices support power saving and doze/standby/suspend modes.

### DVD / HDD Solution :

The Panel PC also provides one Standard Slim DVD ROM/Combo/Dual (Optional) for choice.

### 1.3 System Specification

Table 1.1 System Specification

Form Factor	Mini-ITX
CPU Socket	Socket 479 or CPU on board
CPU	Intel Pentium M/Celeron M up to 2.0GHz
Front Side Bus	400 MHz
Chipset	Intel 855 GME/852 GM ICH4
Memory	One 184-pin DDR DIMM Max.1GB
BIOS	Award 4Mbit
VGA Controller	Intel 855GME integrated
VGA Memory	Shared memory Max. 64MB
LCD Support	24-bit LVDS (dual channel)
Ethernet	Intel ICH4 integrated + PHY 82565EZ Intel 82541 GI Gigabit Ethernet
Audio	Built-in audio+AC97 codec
IDE	2 U DMA33/66/100
SATA	N/A
Super I/O Chipset	W83627HF
Parallel	1 SPP/EPP/ECP port
Serial	2 RS232
Fire Wire	2 1394
USB	2 port on board Pin header for 4 ports(USB 2.0)
KB / Mouse Connector	PS/2
DVD ( Optional )	Standard Slim DVD ROM/Combo/Dual (15" to 19")
Watchdog Timer	256 levels
Expansion Slots	Mini PCI , Internal/socket
Power Adapter	DC In 12V or 19V
Operation temperature	0~45(°C)
IP65	Optional

## 1.4 LCD Specification

Table 1.2 LCD Specification

Item Size	Resolution	Display Colors
R08B89T- XXM1	640x480	262144 (6bit / colors)
R08B89T- XXU1	800x600	262144 (6bit / colors)
R08B89T- XXT1	800x600	262144 (6bit / colors)
R10B89T- XXP1	800x600	262144 (6bit / colors)
R10B89T- XXP3	640x480	260K
R10B89T- XXU1	800x600	262144 (6bit / colors)
R10B89T- XXH1	1024x768	262144 (6bit / colors)
R10B89T- XXM2	800x600	16.7M (8bitS/color)
R12B89T- XXL1	800x600	262144 (6bit / colors)
R12B89T- XXL2	800x600	262,144 (6bit/colors)
R12B89T- XXM1	800x600	262144 (6bit / colors)
R12B89T- XXM2	1024x768	262,144 (6bit/colors)
W12L100- XXM4	1280x800	262,144 (6bit/colors)
R15B89T- XXC3	1024x768	16.2M (6bit+FRC)
R15B89T- XXC5	1024x768	16.2M (6bit+FRC)

R15B89T- XXA1	1024x768	262,144 (6bit/colors)
W15B89T- XXM2	1280x800	262,144 (6bit/colors)
W15B89T- XXM3	1280x800	262,144 (6bit/colors)
W17B89T- XXA1	1280x768	16.2M (6bit+FRC)
R17B89T- XXA3	1280x1024	16.2M (8bit/colors)
R17B89T- XXM1	1280x1024	16.2M (8bit/colors)
R19B89T- XXM1	1280x1024	16.7M (8bit/colors)
R19B89T- XXA1	1280x1024	16.2M (6bit+FRC)
R20B89T- XXA2	1600x1200	260K
W20B89T- XXA3	1366x768	16.2M (6bit+FRC)
W23B89T- XXQ1	1280x768	16.7M (8bit/colors)
W26B89T- XXA2	1280x768	16.7M (8bit/colors)
W32B89T- XXA1	1366x768	16.7M (8bit/colors)
W37B89T- XXA2	1366x768	16.7M (8bit/colors)
W42B89T- XXL1	1366x768	16.7M (8bit/colors)

### 1.5 Mechanical Drawing

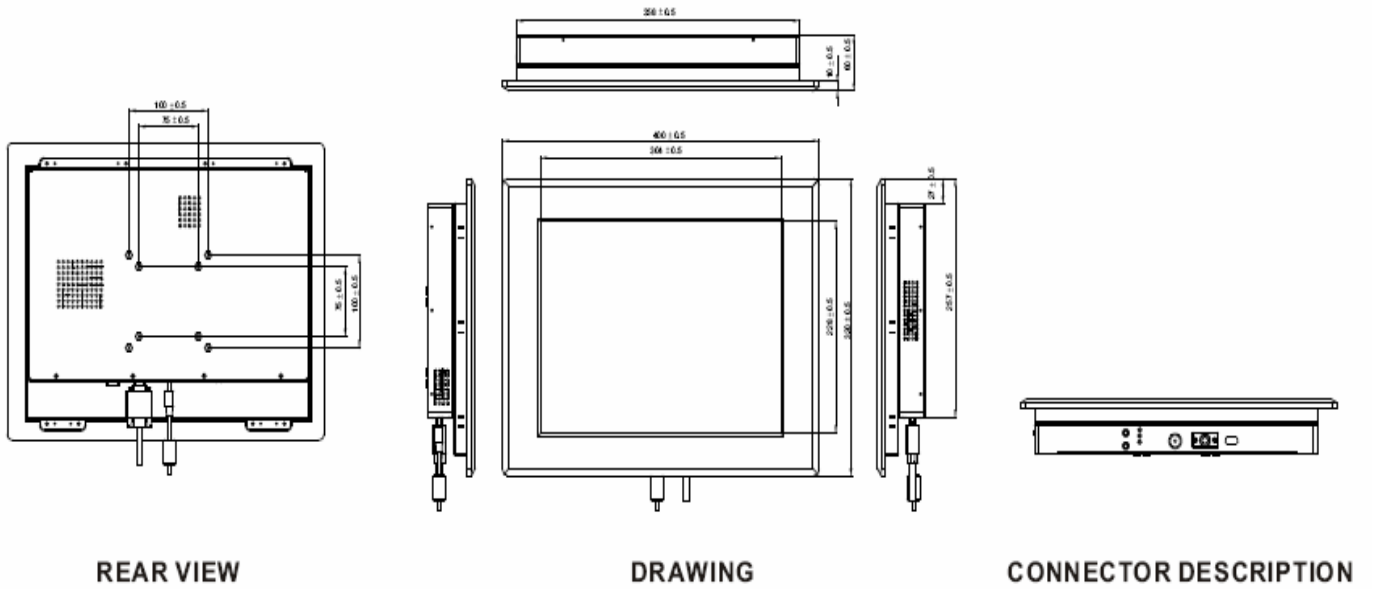

*Figure 1.2 Dimensions of the R15B89T-IPC3*

### 1.6 Input / Output Devices

The following figure shows the I/O arrangement of the Panel PC. The backside of the chassis contains most of the connectors.

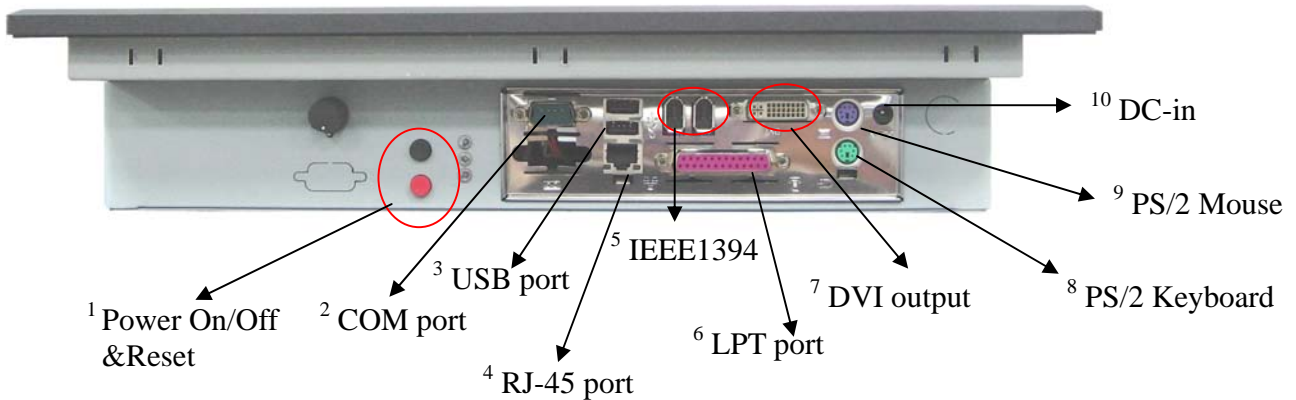

1	Power On/Off & Reset	Put on/off and reset the power on your computer. The Power hot key is located in the right of upward view in the Panel PC.
2	COM port	9-pin male Serial Port connector that can attach a serial mouse or other serial devices directly to the port.
3	USB port	USB-compatible devices can be plugged directly into the USB 2.0 port.
4	RJ-45 port	Connect a network cable to the standard RJ-45 port and get connection to the Local Area Network (LAN).
5	IEEE1394	6-pin IEEE1394 connector that can attach some digital electronic instruments as DV, DSC to the port.
6	LPT port	25-pin female parallel port that connect to printer.
7	DVI port	A DVI port that connect PPC to other LCD monitor.
8	PS/2 port	Connect Keyboard to the PS/2 port.
9	PS/2 port	Connect Mouse to the PS/2 port.
10	DC-in jack	Connect the power cord to the AC outlet, and connect the power to the monitor through the AC/DC adapter.



## Hardware Installation

This chapter gives hardware installation details to the Panel PC.

Sections include:

- HDD Installation
- DVD ROM Installation

## Chapter 2 Hardware Installation

The PPC is a PC-based industrial computer that is housed in aluminum alloy front panel and heavy-duty steel chassis. And the following section will show the HDD and DVD-ROM installation process.

### 2.1 DVD ROM Installation

The PPC has a Standard Slim DVD ROM/Combo/Dual for choice (15" to 19").

When installing the DVD ROM, please follow the steps below:

Step 1. Take out the screws and remove the PPC back cover.

Step 2. Fasten the DVD ROM to the drives shelf by 4 screws.

Step 3. Fasten screws on the side cover of the PPC.

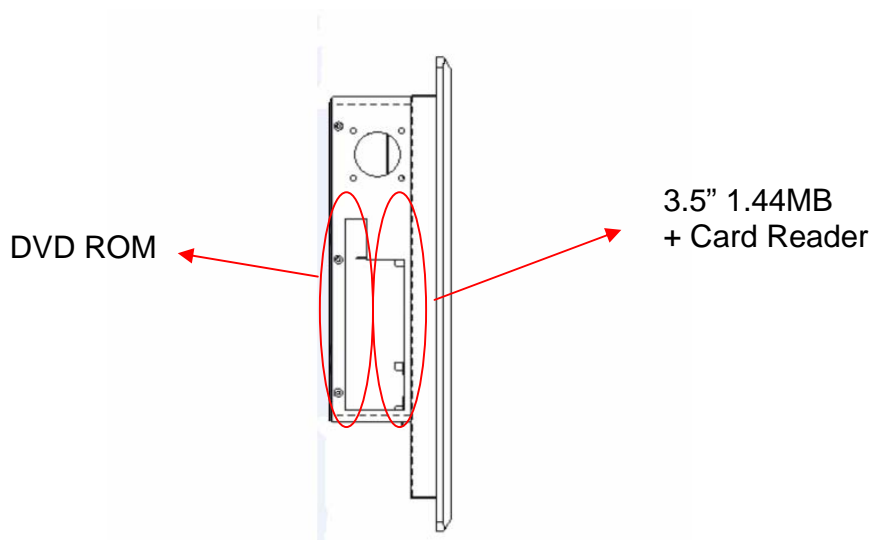

*Figure 2.1 DVD ROM position of the R15B89T-IPC3*

## 2.2 HDD Installation

The PPC has a IDE connector for 3.5" HDD, the user can install 3.5"HDD easily by removing the side cover of HDD drive bay.

If the user intends to install DVD ROM and HDD, follow the steps below :

Step 1. Take out the screws and remove the PPC back cover.

Step 2~4. Fasten DVD with shelf by 4 screws. Fix DVD ROM within the Panel PC with 4 screws. Connect IDE cable to the DVD IDE pin connector. Match pin 1 of the DVD and the pin 1 of the cable.

Step 5~6. Fasten the HDD to the drives shelf by 4 screws.

Step 7. Fix HDD within the Panel PC above the DVD ROM. Fasten the HDD drive shelf inside with 4 screws.

Step8. Use the IDE cable to connect the HDD to the IDE pin connector. Match pin 1 of the HDD and the pin 1 of the cable. Connect HDD power connector as the picture showed below.

Step 9. Fasten screws on the side cover of the PPC.

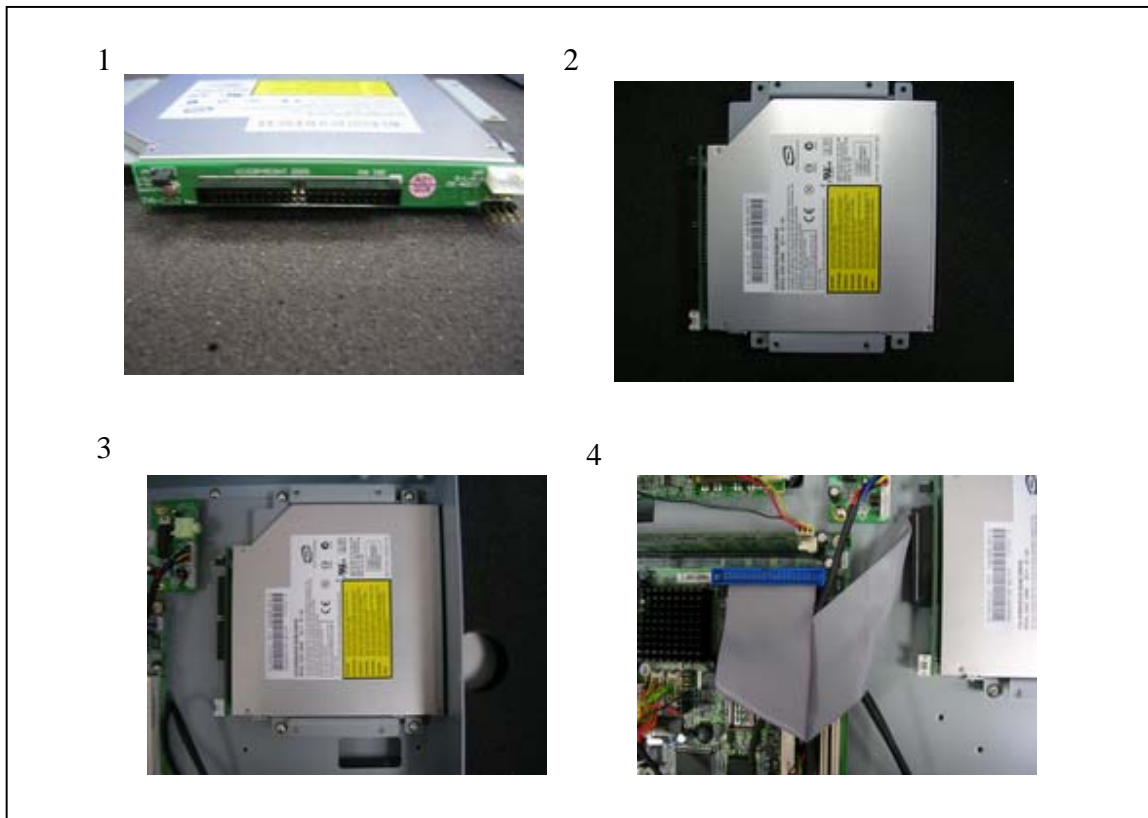

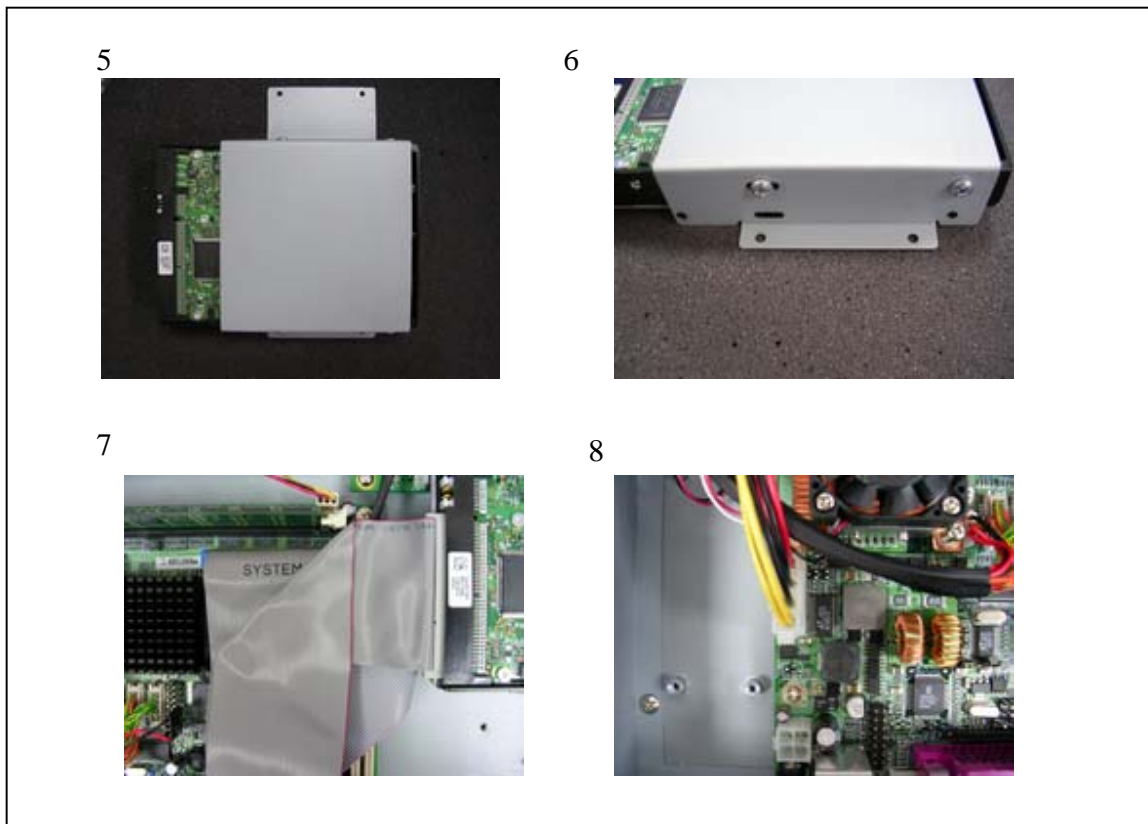

*Figure 2.2 HDD Installation of the R15B89T-IPC3*

# CAPTER 3

## Setting Jumpers and Connectors

This chapter describes the Jumpers and Connectors setting to the Panel PC. Be sure to read the safety precautions before your installation.

Sections include:

- Jumpers and Connectors
- Setting Jumpers
- Connector Definition

## Chapter 3 Settings Jumpers and Connectors

### 3.1 Jumpers and Connectors

#### 3.1.1 Jumper and Connector Layout

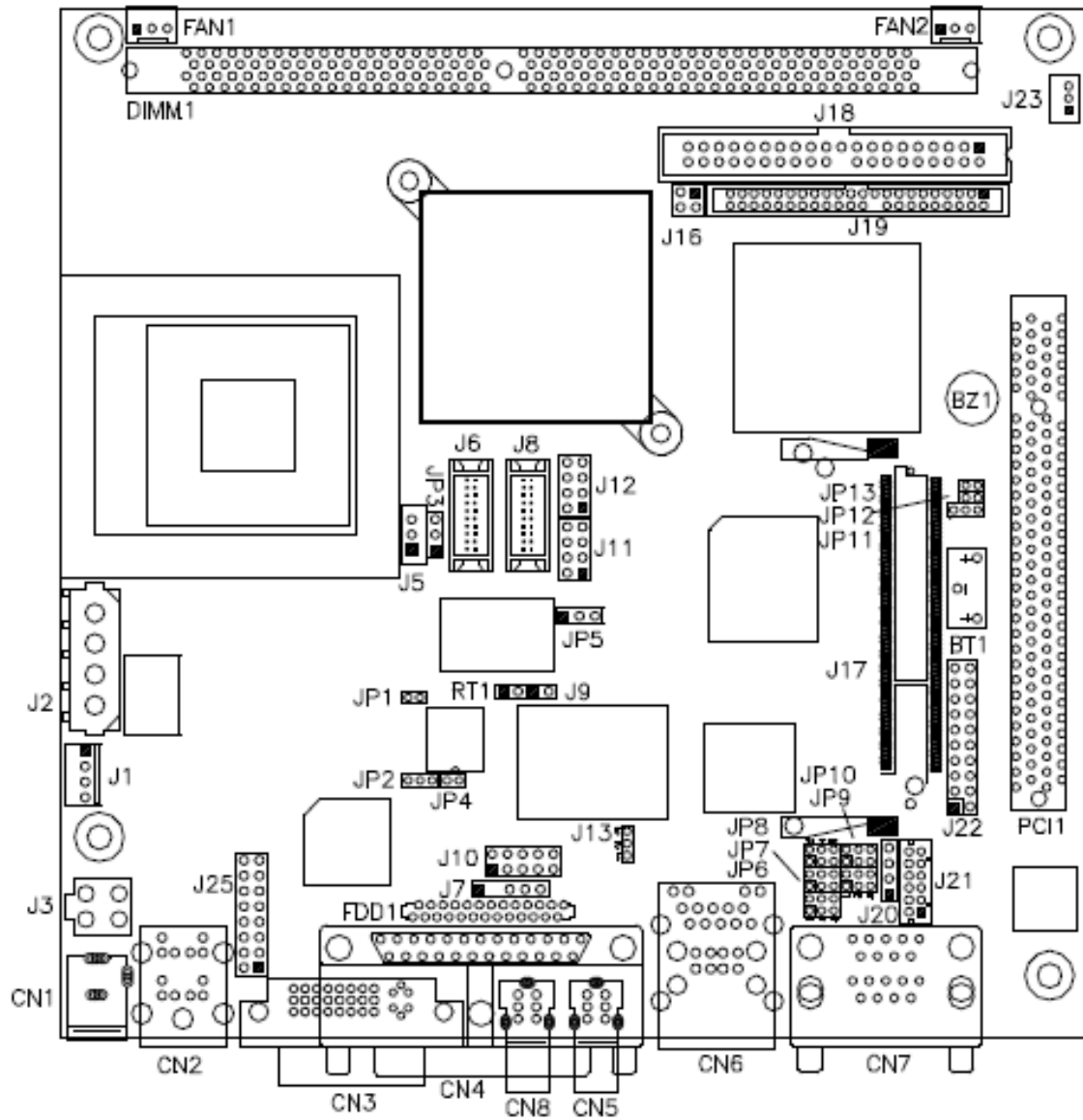

Figure 3.1 Jumper and Connector Layout

### 3.1.2 Jumpers and Connectors

Connectors on the board are linked to external devices such as hard disk drives, keyboard, or floppy drives. In addition, the board has a number of jumpers that allow you to configure your system to suit your application.

The following tables list the function of each of the board's jumpers and connectors.

Table 3.1 Jumpers

Label	Function
JP1	CPU Host Clock
JP2	Power Mode Setting
JP3	LVDS Power Setting
JP4	1394 Controller EEPROM Write Protect
JP6, JP7, JP8	RS232/422/485 (COM2) Selection
JP9	COM2 RS232 Pin9 Setting
JP10	COM1 RS232 Pin9 Setting
JP11	Clear CMOS Contents
JP13	Compact Flash Mode Setting
J13	Intel® 82541GI Gigabit LAN Enable/Disable



Table 3.2 Connectors

Label	Function
CN1	DC Jack for DC Adaptor
CN2	PS/2 Keyboard and PS/2 Mouse Connectors
CN3	DVI-I Connector
CN4	Parallel Port Connector
CN5, CN8	1394 Connectors
CN6	RJ45 and 2 USB Ports
CN7	COM1 and COM2 Serial Ports
J2	HDD Power Connector
J3	Internal DC-In Power Connector
J5	LCD Backlight Setting
J6, J8	Panel Connectors (1st channel, 2nd channel)
J7	IrDA Connector
J10	Digital I/O
J11, J12	USB Port Pin Header
J16	HDD Power Pin Header
J17	Mini PCI Socket
J18, J19	Primary and Secondary IDE Connectors
J20	CD-In Pin Header
J21	External Audio Connector
J22	System Function Connector
J23	Wake On LAN Connector
J24	Compact Flash Socket
J25	VGA CRT Connector
FAN1	CPU Fan Power Connector
FAN2	System Fan Power Connector



### 3.2 Setting Jumpers

#### 3.2.1 CPU Host Clock(JP1)

SEL-0	SEL_1 (JP1)	SEL_2	Host Clock
1	 Short	0	100MHz (default)
1	 Open	0	133MHz

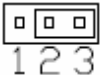

#### 3.2.2 Power Mode Setting(JP2)

JP2	Power Mode
 1 2 3	Simulate ATX Power Mode (default)
 1 2 3	AT Power Mode

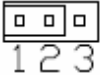
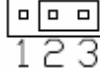
#### 3.2.3 LVDS Power Setting(JP3)

JP3	LVDS Power
 1 2 3	+3.3V (default)
 1 2 3	+5V

#### 3.2.4 1394 Controller EEPROM Write Protect(JP4)

JP4	Function
 Open	Write Disable
 Short	Write Enabled

**3.2.5 RS232/422/485 (COM2) Selection(JP6, JP7, JP8)**

COM1 is fixed for RS-232 use only.

COM2 is selectable for RS232, RS-422 and RS-485.

The following table describes the jumper settings for COM2 selection.

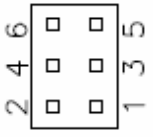

COM2 Function	RS-232	RS-422	RS-485
Jumper Setting (pin closed)	JP6: 3-5 & 4-6 JP7: 3-5 & 4-6 JP8: 1-2	JP6: 1-3 & 2-4 JP7: 1-3 & 2-4 JP8: 3-4	JP6: 1-3 & 2-4 JP7: 1-3 & 2-4 JP8: 5-6

**3.2.6 COM2 RS232 Pin9 Setting(JP9)**

Pin	Signal	JP9	Signal	Pin
1	RI		+12V	2
3	RI (Default)		RI (Default)	4
5	RI		+5V	6

COM2 Settings: Pin 1-2 short = +12V, Pin 5-6 short = +5V, Pin 3-4 RI Signal (default)

**3.2.7 COM1 RS232 Pin9 Setting(JP10)**

Pin	Signal	JP10	Signal	Pin
1	RI		+12V	2
3	RI (Default)		RI (Default)	4
5	RI		+5V	6

COM1 Settings: Pin 1-2 short = +12V, Pin 5-6 short = +5V, Pin 3-4 RI Signal

3.2.8 Clear CMOS Contents(JP11)

Use JP11 to clear the CMOS contents. Note that the ATX-power connector should be disconnected from the board before clearing CMOS.

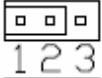
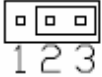
JP11	Setting	Function
	Pin 1-2 Short/Closed	Normal
	Pin 2-3 Short/Closed	Clear CMOS

3.2.9 Compact Flash Mode Setting(JP13)

JP13	CF Mode
	Slave
	Master

3.2.10 Intel® 82541GI Gigabit LAN Enable/Disable(J13)

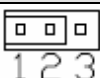
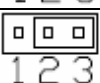
J13	Gigabit LAN
	Enable
	Disable

### 3.3 Connector Definitions

#### 3.3.1 DC Jack for DC Adaptor (CN1)

The DC jack accepts input of 12V or 19V.

#### 3.3.2 PS/2 Keyboard and PS/2 Mouse Connectors (CN2)

Signal	Keyboard	Mouse	Signal
Keyboard data	1	1	Mouse data
N.C.	2	2	N.C.
GND	3	3	GND
5V	4	4	5V
Keyboard clock	5	5	Mouse clock
N.C.	6	6	N.C.

#### 3.3.3 DVI-I Connector (CN3)

Signal	PIN		Signal
DATA 2-	1	16	HOT POWER
DATA 2+	2	17	DATA 0-
Shield 2/4	3	18	DATA 0+
DATA 4-	4	19	SHIELD 0/5
DATA 4+	5	20	DATA 5-
DDC CLOCK	6	21	DATA 5+
DDC DATA	7	22	SHIELD CLK
VSYNC	8	23	CLOCK -
DATA 1-	9	24	CLOCK +
DATA 1+	10	C1	A RED
SHIELD 1/3	11	C2	A GREEN
DATA 3-	12	C3	A BLUE
DATA 3+	13	C4	HYNC
DDC POWER	14	C5	A GROUND2
A GROUND 1	15	C6	A GROUND3

### 3.3.4 Parallel Port Connector (CN4)

Signal	PIN		Signal
Line printer strobe	1	14	AutoFeed
PD0, parallel data 0	2	15	Error
PD1, parallel data 1	3	16	Initialize
PD2, parallel data 2	4	17	Select
PD3, parallel data 3	5	18	Ground
PD4, parallel data 4	6	19	Ground
PD5, parallel data 5	7	20	Ground
PD6, parallel data 6	8	21	Ground
PD7, parallel data 7	9	22	Ground
ACK, acknowledge	10	23	Ground
Busy	11	24	Ground
Paper empty	12	25	Ground
Select	13	N/A	Ground

### 3.3.5 RJ45 and 2 USB Ports (CN6)

CN6 is a stacked connector with RJ45 on top and 2 USB ports at the bottom.

### 3.3.6 COM1 and COM2 Serial Ports (CN7)

CN7 is a stacked connector with COM1 on top and COM2 at the bottom.

Signal	PIN		Signal
DCD, Data carrier detect	1	6	RXD, Receive data
TXD, Transmit data	2	7	DTR, Data terminal ready
GND, ground	3	8	DSR, Data set ready
RTS, Request to send	4	9	CTS, Clear to send
RI, Ring indicator	5	10	Not Used

COM2 is jumper selectable for RS-232, RS-422 and RS-485.

PIN	Signal		
	RS-232	RS-422	RS-485
1	DCD	TX-	DATA-
2	RX	TX+	DATA+
3	TX	RX+	NC
4	DTR	RX-	NC
5	Ground	Ground	Ground
6	DSR	RTS-	NC
7	RTS	RTS+	NC
8	CTS	CTS+	NC
9	RI	CTS-	NC
10	NC	NC	NC

3.3.7 HDD Power Connector (J2)

Pin	Signal
1	+12V
2	Ground
3	Ground
4	5V

3.3.8 Internal DC-In Power Connector (J3)

Pin	Signal
1	Ground
2	Ground
3	+12V or 19V
4	+12V or 19V

3.3.9 LCD Backlight Setting (J5)

Pin	Signal
1	+12V
2	Backlight Enable
3	Ground

3.3.10 Panel Connectors (1st channel, 2nd channel) (J6, J8)

The Panel connectors on board consist of the first channel (J6) and second channel (J8) and supports 24-bit or 48-bit.

Signal	PIN		Signal
TX0-	2	1	TX0+
Ground	4	3	Ground
TX1-	6	5	TX1+
5V/3.3V	8	7	Ground
TX3-	10	9	TX3+
TX2-	12	11	TX2+
Ground	14	13	Ground
TXC-	16	15	TXC+
5V/3.3V	18	17	ENABKL
+12V	20	19	+12V

**3.3.11 IrDA Connector (J7)**

J7 is used for an optional IrDA connector for wireless communication.

Pin	Signal
1	+5V
2	No connect
3	Ir RX
4	Ground
5	Ir TX

**3.3.12 Digital I/O (J10)**

Signal	PIN		Signal
GND	1	2	VCC
OUT3	3	4	OUT1
OUT2	5	6	OUT0
IN3	7	8	IN1
IN2	9	10	IN0

**3.3.13 USB Port Pin Header (J11, J12)**

Signal	PIN		Signal
Vcc	1	5	Ground
D-	2	6	D+
D+	3	7	D
Ground	4	8	Vcc

**3.3.14 HDD Power Pin Header (J16)**

Signal	PIN		Signal
Vcc	2	1	Vcc
NC	4	3	Ground

**3.3.15 Mini PCI Socket (J17)**

3.3.16 Primary and Secondary IDE Connectors (J18, J19)

Signal	PIN		Signal
Reset IDE	1	2	Ground
Host data 7	3	4	Host data 8
Host data 6	5	6	Host data 9
Host data 5	7	8	Host data 10
Host data 4	9	10	Host data 11
Host data 3	11	12	Host data 12
Host data 2	13	14	Host data 13
Host data 1	15	16	Host data 14
Host data 0	17	18	Host data 15
Ground	19	20	Protect pin
DRQ0	21	22	Ground
Host IOW	23	24	Ground
Host IOR	25	26	Ground
IOCHRDY	27	28	Host ALE
DACK0	29	30	Ground
IRQ14	31	32	No connect
Address 1	33	34	No connect
Address 0	35	36	Address 2
Chip select 0	37	38	Chip select 1
Activity	39	40	Ground

3.3.17 Secondary IDE Connector (J19)

Signal	PIN		Signal
Reset IDE	1	2	Ground
Host data 7	3	4	Host data 8
Host data 6	5	6	Host data 9
Host data 5	7	8	Host data 10
Host data 4	9	10	Host data 11
Host data 3	11	12	Host data 12
Host data 2	13	14	Host data 13
Host data 1	15	16	Host data 14
Host data 0	17	18	Host data 15
Ground	19	20	Key
DRQ0	21	22	Ground
Host IOW	23	24	Ground
Host IOR	25	26	Ground
IOCHRDY	27	28	Host ALE
DACK0	29	30	Ground
IRQ14	31	32	No connect
Address 1	33	34	No connect
Address 0	35	36	Address 2
Chip select 0	37	38	Chip select 1
Activity	39	40	Ground
Vcc	41	42	Vcc
Ground	43	44	N.C.



**3.3.18 CD-In Pin Header (J20)**

Pin	Signal
1	CD Audio R
2	Ground
3	Ground
4	CD Audio L

**3.3.19 External Audio Connector (J21)**

J21 is a 12-pin header that is used to connect to the optional audio cable card that integrates jacks for Line In, Line Out and Mic.

Signal	PIN	Signal
LINEOUT_R	1 2	LINEOUT_L
Ground	3 4	Ground
LINEIN_R	5 6	LINEIN L
Ground	7 8	Ground
Mic-In	9 10	VREFOUT
Ground	11 12	Protect pin

**3.3.20 System Function Connector (J22)**

J22 provides connectors for system indicators that provide light indication of the computer activities and switches to change the computer status. J22 is a 20-pin header that provides interfaces for the following functions.



Signal Name	Pin	Pin	Signal Name
SP+	1	2	SP-
Ground	3	4	EXT_SMI_SW
Ground	5	6	PWR_BTN
Ground	7	8	Reset
HDD LED+	9	10	HDD LED-

Speaker: Pins 1 – 4

This connector provides an interface to a speaker for audio tone generation. An 8-ohm speaker is recommended.

Pin	Signal
1	Speaker out
2	No connect
3	Ground
4	+5V

**Power LED: Pins 11 – 15**

The power LED indicates the status of the main power switch.

Pin	Signal
1	Power LED
2	No connect
3	Ground
4	No connect
5	Ground

**SMI/Hardware Switch: Pins 6 and 16**

This connector supports the "Green Switch" on the control panel, which, when pressed, will force the system into the power-saving mode immediately.

Pin	Signal
1	SMI
2	Ground

**ATX Power ON Switch: Pins 7 and 17**

This 2-pin connector is an "ATX Power Supply On/Off Switch" on the system that connects to the power switch on the case. When pressed, the power switch will force the system to power on. When pressed again, it will force the system to power off.

**Reset Switch: Pins 9 and 19**

The reset switch allows the user to reset the system without turning the main power switch off and then on again. Orientation is not required when making a connection to this header.

**Hard Disk Drive LED Connector: Pins 10 and 20**

This connector connects to the hard drive activity LED on control panel. This LED will flash when the HDD is being accessed.

Pin	Signal
1	HDD Active
2	5V

**3.3.21 Wake On LAN Connector (J23)**

J23 is a 3-pin header for the Wake On LAN function. Wake On LAN will function properly only with an ATX power supply with 5VSB that has 200mA.

Pin	Signal
1	+5VSB
2	Ground
3	-PME

3.3.22 Compact Flash Socket (J24)3.3.23 VGA CRT Connector (J25)

Signal	PIN		Signal
R	1	9	+5V
G	2	10	GND
B	3	11	NC
NC	4	12	DDCDAT
GND	5	13	HSYNC
GND	6	14	VSYNC
GND	7	15	DDCCLK
GND	8	16	TV out

3.3.24 CPU Fan Power Connector (FAN1)

FAN1 is a 3-pin header for the CPU fan. The fan must be a 12V fan.

Pin	Signal
1	Ground
2	+12V
3	Rotation detection

3.3.25 System Fan Power Connector (FAN2)

FAN2 is a 3-pin header for system fans. The fan must be a 12V (500mA) fan.

Pin	Signal
1	Ground
2	+12V
3	Rotation detection

CAPTE**R**  
**4**

AWARD BIOS Setup

This chapter describes how to set BIOS configuration data.

Sections include:

- Setting Setup
- Using Setup
- Getting Help
- In Case of Problems
- Main Menu

## Chapter 4 AWARD BIOS Setup

### 4.1 Starting Setup

The Award BIOS™ is immediately activated when you first power on the computer. The BIOS reads the system information contained in the CMOS and begins the process of checking out the system and configuring it. When it finishes, the BIOS will seek an operating system on one of the disks and then launch and turn control over to the operating system.

While the BIOS is in control, the Setup program can be activated in one of two ways:

By pressing <Del> immediately after switching the system on, or

By pressing the <Del> key when the following message appears briefly at the bottom of the screen during the POST (Power On Self Test).

Press DEL to enter SETUP

If the message disappears before you respond and you still wish to enter Setup, restart the system to try again by turning it OFF then ON or pressing the "RESET" button on the system case. You may also restart by simultaneously pressing <Ctrl>, <Alt>, and <Delete> keys. If you do not press the keys at the correct time and the system does not boot, an error message will be displayed and you will again be asked to.

Press F1 to Continue, DEL to enter SETUP

## 4.2 Using Setup

In general, you use the arrow keys to highlight items, press <Enter> to select, use the PageUp and PageDown keys to change entries, press <F1> for help and press <Esc> to quit. The following table provides more detail about how to navigate in the Setup program using the keyboard.

Table 4.1 Legend Keys

Up arrow	Move to previous item
Down arrow	Move to next item
Left arrow	Move to the item in the left hand
Right arrow	Move to the item in the right hand
Esc key	Main Menu -- Quit and not save changes into CMOS Status Page Setup Menu and Option Page Setup Menu -- Exit current page and return to Main Menu
PgUp key	Increase the numeric value or make changes
PgDn key	Decrease the numeric value or make changes
+ key	Increase the numeric value or make changes
- key	Decrease the numeric value or make changes
F1 key	General help, only for Status Page Setup Menu and Option Page Setup Menu
(Shift) F2 key	Change color from total 16 colors. F2 to select color forward, (Shift) F2 to select color backward
F3 key	Calendar, only for Status Page Setup Menu
F4 key	Reserved
F5 key	Restore the previous CMOS value from CMOS, only for Option Page Setup Menu
F6 key	Load the default CMOS value from BIOS default table, only for Option Page Setup Menu
F7 key	Load the default
F8 key	Reserved
F9 key	Reserved
F10 key	Save all the CMOS changes, only for Main Menu

### 4.2.1 Navigating Through The Menu Bar

Use the left and right arrow keys to choose the menu you want to be in.

### 4.2.2 To Display a Sub Menu

Use the arrow keys to move the cursor to the sub menu you want. Then press <Enter>. A “➤” pointer marks all sub menus.

### 4.3 Getting Help

Press F1 to pop up a small help window that describes the appropriate keys to use and the possible selections for the highlighted item. To exit the Help Window press <Esc> or the F1 key again.

### 4.4 In Case of Problems

If, after making and saving system changes with Setup, you discover that your computer no longer is able to boot, the AwardBIOS™ supports an override to the CMOS settings which resets your system to its defaults.

The best advice is to only alter settings which you thoroughly understand. To this end, we strongly recommend that you avoid making any changes to the chipset defaults. These defaults have been carefully chosen by both Award and your systems manufacturer to provide the absolute maximum performance and reliability. Even a seemingly small change to the chipset setup has the potential for causing you to use the override.

### 4.5 Main Menu

Once you enter the AwardBIOS™ CMOS Setup Utility, the Main Menu will appear on the screen. The Main Menu allows you to select from several setup functions and two exit choices. Use the arrow keys to select among the items and press <Enter> to accept and enter the sub-menu.

Phoenix - AwardBIOS CMOS Setup Utility

Standard CMOS Features	Frequency/Voltage Control
Advanced BIOS Features	Load Fail-Safe Defaults
Advanced Chipset Features	Load Optimized Defaults
Integrated Peripherals	Set Supervisor Password
Power Management Setup	Set User Password
PnP/PCI Configurations	Save & Exit Setup
PC Health Status	Exit Without Saving
ESC : Quit	↑ ↓ → ← : Select Item
F10 : Save & Exit Setup	
Time, Date, Hard Disk Type...	

Note that a brief description of each highlighted selection appears at the bottom of the screen.

### 4.5.1 Standard CMOS Features

The items in Standard CMOS Features Menu are divided into 10 categories. Each category includes no, one or more than one setup items. Use the arrow keys to highlight the item and then use the <PgUp> or <PgDn> keys to select the value you want in each item.

Phoenix - AwardBIOS CMOS Setup Utility  
Standard CMOS Features

		Item Help
Date (mm:dd:yy)	Wed, Apr 28, 2004	Menu Level >  Change the day, month, Year and century
Time (hh:mm:ss)	00 : 00 : 00	
IDE Primary Master	None	
IDE Primary Slave	None	
IDE Secondary Master	None	
IDE Secondary Slave	None	
Drive A	1.44M, 3.5 in.	
Drive B	None	
Video	EGA/VGA	
Halt On	All Errors	
Base Memory	640K	
Extended Memory	129024K	
Total Memory	130048K	



#### 4.5.1.1 Main Menu Selection

This table shows the selections that you can make on the Main Menu.

Table 4.2 Main Menu Selection

Item	Options	Description
Date	Month DD YYYY	Set the system date. Note that the 'Day' automatically changes when you set the date
Time	HH : MM : SS	Set the system time
IDE Primary Master	Options are in its sub menu (described in Table 3)	Press <Enter> to enter the sub menu of detailed options
IDE Primary Slave	Options are in its sub menu (described in Table 3)	Press <Enter> to enter the sub menu of detailed options
IDE Secondary Master	Options are in its sub menu (described in Table 3)	Press <Enter> to enter the sub menu of detailed options
IDE Secondary Master	Options are in its sub menu (described in Table 3)	Press <Enter> to enter the sub menu of detailed options
Drive A Drive B	None 360K, 5.25 in 1.2M, 5.25 in 720K, 3.5 in 1.44M, 3.5 in 2.88M, 3.5 in	Select the type of floppy disk drive installed in your system
Video	EGA/VGA CGA 40 CGA 80 MONO	Select the default video device
Halt On	All Errors No Errors All, but Keyboard All, but Diskette All, but Disk/Key	Select the situation in which you want the BIOS to stop the POST process and notify you
Base Memory	N/A	Displays the amount of conventional memory detected during boot up
Extended Memory	N/A	Displays the amount of extended memory detected during boot up
Total Memory	N/A	Displays the total memory available in the system

4.5.1.2 IDE Adapters

The IDE adapters control the hard disk drive. Use a separate sub menu to configure each hard disk drive.

Use the legend keys to navigate through this menu and exit to the main menu. Use Table 5.3 to configure the hard disk.

Table 4.3 Hard Disk Selection

Item	Options	Description
IDE HDD Auto-detection	Press Enter	Press Enter to auto-detect the HDD on this channel. If detection is successful, it fills the remaining fields on this menu.
IDE Primary Master	None Auto Manual	Selecting 'manual' lets you set the remaining fields on this screen. Selects the type of fixed disk. "User Type" will let you select the number of cylinders, heads, etc. Note: PRECOMP=65535 means NONE !
Capacity	Auto Display your disk drive size	Disk drive capacity (Approximated). Note that this size is usually slightly greater than the size of a formatted disk given by a disk checking program.
Access Mode	Normal LBA Large Auto	Choose the access mode for this hard disk

The following options are selectable only if the 'IDE Primary Master' item is set to 'Manual'

Cylinder	Min = 0 Max = 65535	Set the number of cylinders for this hard disk.
Head	Min = 0 Max = 255	Set the number of read/write heads
Precomp	Min = 0 Max = 65535	**** Warning: Setting a value of 65535 means no hard disk ****
Landing zone	Min = 0 Max = 65535	
Sector	Min = 0 Max = 255	Number of sectors per track

4.5.2 Advanced BIOS Features

This section allows you to configure your system for basic operation. You have the opportunity to select the system's default speed, boot-up sequence, keyboard operation, shadowing and security.

Phoenix - AwardBIOS CMOS Setup Utility  
Advanced BIOS Features

CPU Feature	Press Enter	ITEM HELP
Virus Warning	Disabled	Menu Level >
CPU L1 and L2 Cache	Enabled	
CPU L3 Cache	Enabled	
Quick Power On Self Test	Enabled	
First Boot Device	Floppy	
Second Boot Device	HDD-0	
Third Boot Device	CDROM	
Boot Other Device	Enabled	
Swap Floppy Drive	Disabled	
Boot Up Floppy Seek	Disabled	
Boot Up NumLock Status	On	
Gate A20 Option	Fast	
Typematic Rate Setting	Disabled	
Typematic Rate (Chars/Sec)	6	
Typematic Delay (Msec)	250	
Security Option	Setup	
APIC Mode	Enabled	
MPS Version Control for OS	1.4	
OS Select For DRAM>64MB	Non-OS2	
Report No FDD For WIN 95	Yes	
Small Logo (EPA) Show	Enabled	

4.5.2.1 CPU Feature

Press Enter to configure the settings relevant to CPU Feature.

4.5.2.2 Virus Warning

If this option is enabled, an alarm message will be displayed when trying to write on the boot sector or on the partition table on the disk, which is typical of the virus.

4.5.2.3 CPU L1 and L2 Cache / CPU L3 Cache

Cache memory is additional memory that is much faster than conventional DRAM (system memory). CPUs from 486-type on up contain internal cache memory, and most, but not all, modern PCs have additional (external) cache memory. When the CPU requests data, the system transfers the requested data from the main DRAM into cache memory, for even faster access by the CPU. These items allow you to enable (speed up memory access) or disable the cache function. By default, these items are Enabled.

#### 4.5.2.4 Quick Power On Self Test

When enabled, this field speeds up the Power On Self Test (POST) after the system is turned on. If it is set to Enabled, BIOS will skip some items.

#### 4.5.2.5 First/Second/Third Boot Device

These fields determine the drive that the system searches first for an operating system. The options available include Floppy, LS120, HDD-0, SCSI, CDROM, HDD-1, HDD-2, HDD-3, ZIP100, USB-FDD, USB-CDROM, USB-HDD and Disable.

#### 4.5.2.6 Boot Other Device

These fields allow the system to search for an OS from other devices other than the ones selected in the First/Second/Third Boot Device.

#### 4.5.2.7 Swap Floppy Drive

This item allows you to determine whether or not to enable Swap Floppy Drive. When enabled, the BIOS swaps floppy drive assignments so that Drive A becomes Drive B, and Drive B becomes Drive A. By default, this field is set to Disabled.

#### 4.5.2.8 Boot Up Floppy Seek

This feature controls whether the BIOS checks for a floppy drive while booting up. If it cannot detect one (either due to improper configuration or its absence), it will flash an error message.

#### 4.5.2.9 Boot Up NumLock Status

This allows you to activate the NumLock function after you power up the system.

#### 4.5.2.10 Gate A20 Option

This field allows you to select how Gate A20 is worked. Gate A20 is a device used to address memory above 1 MB.

#### 4.5.2.11 Typematic Rate Setting

When disabled, continually holding down a key on your keyboard will generate only one instance. When enabled, you can set the two typematic controls listed next. By default, this field is set to Disabled.

#### 4.5.2.12 Typematic Rate (Chars/Sec)

When the typematic rate is enabled, the system registers repeated keystrokes speeds. Settings are from 6 to 30 characters per second.

#### 4.5.2.13 Typematic Delay (Msec)

When the typematic rate is enabled, this item allows you to set the time interval for displaying the first and second characters. By default, this item is set to 250msec.

#### 4.5.2.14 Security Option

This field allows you to limit access to the System and Setup. The default value is Setup. When you select System, the system prompts for the User Password every time you boot up. When you select Setup, the system always boots up and prompts for the Supervisor Password only when the Setup utility is called up.

#### 4.5.2.15 APIC Mode

APIC stands for Advanced Programmable Interrupt Controller. The default setting is Enabled.

#### 4.5.2.16 MPS Version Control for OS

This option is specifies the MPS (Multiprocessor Specification) version for your operating system. MPS version 1.4 added extended configuration tables to improve support for multiple PCI bus configurations and improve future expandability. The default setting is 1.4.

#### 4.5.2.17 OS Select for DRAM > 64MB

This option allows the system to access greater than 64MB of DRAM memory when used with OS/2 that depends on certain BIOS calls to access memory. The default setting is Non-OS/2.

#### 4.5.2.18 Report No FDD For WIN 95

If you are using Windows 95/98 without a floppy disk drive, select Enabled to release IRQ6. This is required to pass Windows 95/98's SCT test. You should also disable the Onboard FDC Controller in the Integrated Peripherals screen when there's no floppy drive in the system. If you set this feature to Disabled, the BIOS will not report the missing floppy drive to Win95/98.

#### 4.5.2.19 Small Logo (EPA) Show

The EPA logo appears at the right side of the monitor screen when the system is boot up. The default setting is Enabled.

### 4.5.3 Advanced Chipset Features

Phoenix - AwardBIOS CMOS Setup Utility		ITEM HELP
Advanced Chipset Features		Menu Level >
DRAM Timing Selectable	By SPD	
CAS Latency Time	2	
Active to Precharge Delay	6	
DRAM RAS# to CAS# Delay	3	
DRAM RAS# Precharge	3	
DRAM Data Integrity Mode	ECC	
MGM Core Frequency	Auto Max 266MHz	
System BIOS Cacheable	Enabled	
Video BIOS Cacheable	Enabled	
Memory Hole at 15M-16M	Disabled	
Delayed Transaction	Enabled	
Delay Prior to Thermal	16 Min	
AGP Aperture Size (MB)	64	
<b>** On-Chip VGA Setting **</b>		
On-Chip VGA	Enabled	
On-Chip Frame Buffer Size	32MB	
Boot Display	CRT+DVI	
TV Standard	Off	
Video Connector	Automatic	
TV Format	Auto	
Panel Scaling	Auto	
Panel Number	1024x768 18bit SC	

#### 4.5.3.1 DRAM Timing Selectable

This option refers to the method by which the DRAM timing is selected. The default is By SPD.

#### 4.5.3.2 CAS Latency Time

You can configure CAS latency time in HCLKs as 2 or 2.5 or 3. The system board designer should set the values in this field, depending on the DRAM installed. Do not change the values in this field unless you change specifications of the installed DRAM or the installed CPU.

#### 4.5.3.3 Active to Precharge Delay

The default setting for the Active to Precharge Delay is 7.

#### 4.5.3.4 DRAM RAS# to CAS# Delay

This option allows you to insert a delay between the RAS (Row Address Strobe) and CAS (Column Address Strobe) signals. This delay occurs when the SDRAM is

written to, read from or refreshed. Reducing the delay improves the performance of the SDRAM.

#### 4.5.3.5 DRAM RAS# Precharge

This option sets the number of cycles required for the RAS to accumulate its charge before the SDRAM refreshes. The default setting for the Active to Precharge Delay is 3.

#### 4.5.3.6 DRAM Data Integrity Mode

Select ECC if your memory module supports it. The memory controller will detect and correct single-bit soft memory errors. The memory controller will also be able to detect double-bit errors though it will not be able to correct them. This provides increased data integrity and system stability.

#### 4.5.3.7 MGM Core Frequency

This field sets the frequency of the DRAM memory installed. The default setting is Auto Max 266MHz.

#### 4.5.3.8 System BIOS Cacheable

The setting of Enabled allows caching of the system BIOS ROM at F000h-FFFFh, resulting in better system performance. However, if any program writes to this memory area, a system error may result.

#### 4.5.3.9 Video BIOS Cacheable

The Setting Enabled allows caching of the video BIOS ROM at C000h-F7FFFh, resulting in better video performance. However, if any program writes to this memory area, a system error may result.

#### 4.5.3.10 Memory Hole At 15M-16M

In order to improve performance, certain space in memory can be reserved for ISA cards. This memory must be mapped into the memory space below 16 MB. The choices are Enabled and Disabled.

#### 4.5.3.11 Delayed Transaction

The chipset has an embedded 32-bit posted write buffer to support delay transactions cycles. Select Enabled to support compliance with PCI specification version 2.1.

#### 4.5.3.12 Delay Prior to Thermal

This field activates the CPU thermal function after the systems boots for the set number of minutes. The options are 16Min and 64Min.

#### 4.5.3.13 AGP Aperture Size

The field sets aperture size of the graphics. The aperture is a portion of the PCI memory address range dedicated for graphics memory address space. Host cycles that hit the aperture range are forwarded to the AGP without any translation. The default setting is 64M.

#### 4.5.3.14 On-Chip VGA

The default setting is Enabled.

#### 4.5.3.15 On-Chip Frame Buffer Size

The default setting is 32MB. The options available include 1MB, 4MB, 8MB and 16MB.

#### 4.5.3.16 Boot Display

The default setting is CRT+DVI. The options available include some combinations with LVDS and TV-out. The B89 supports dual view (CRT with LVDS or TV-out).

#### 4.5.3.17 TV Standard

The default setting is Off.

#### 4.5.3.18 Video Connector

The default setting is Automatic.

#### 4.5.3.19 TV Format

The default setting is Auto.

#### 4.5.3.20 Panel Scaling

The default setting is Auto. The options available include On and Off.

#### 4.5.3.21 Panel Number

These fields allow you to select the LCD Panel type. The default values for these ports are:

- 640x480
- 800x480
- 800x600
- 1024x768
- 1280x720
- 1280x768
- 1280x1024



- 1366x768
- 1400x1050
- 1600x1200
- 1600x1200A

4.5.3.22 Panel Protocol

These fields allow you to select the LCD Panel Protocol. The default values for these parts are:

- 18bit 1ch
- 24bit 1ch SPGM
- 24bit 1ch OpenLDI
- 18bit 2ch
- 24bit 2ch SPGM
- 24bit 2ch OpenLDI

4.5.4 Integrated Peripherals

This section sets configurations for your hard disk and other integrated peripherals. The first screen shows three main items for user to select. Once an item selected, a submenu appears. Details follow.

Phoenix - AwardBIOS CMOS Setup Utility  
Integrated Peripherals

OnChip IDE Device	Press Enter	ITEM HELP
Onboard Device	Press Enter	Menu Level >
SuperIO Device	Press Enter	

Phoenix - AwardBIOS CMOS Setup Utility  
OnChip IDE Device

On-Chip Primary PCI IDE	Enabled	ITEM HELP
IDE Primary Master PIO	Auto	Menu Level >
IDE Primary Slave PIO	Auto	
IDE Primary Master UDMA	Auto	
IDE Primary Slave UDMA	Auto	
On-Chip Secondary PCI IDE	Enabled	
IDE Secondary Master PIO	Auto	
IDE Secondary Slave PIO	Auto	
IDE Secondary Master UDMA	Auto	
IDE Secondary Slave UDMA	Auto	
IDE HDD Block Mode	Enabled	

Phoenix - AwardBIOS CMOS Setup Utility  
Onboard Device

		ITEM HELP
USB Controller	Enabled	Menu Level >
USB 2.0 Controller	Enabled	
USB Keyboard Support	Disabled	
USB Mouse Support	Disabled	
AC97 Audio	Auto	
Init Display First	PCI Slot	
Power On After Fail	Off	

Phoenix - AwardBIOS CMOS Setup Utility  
SuperIO Device

		ITEM HELP
Onboard FDC Controller	Enabled	Menu Level >
Onboard Serial Port 1	3F8/IRQ4	
Onboard Serial Port 2	2F8/IRQ3	
UART Mode Select	Normal	
RxD , TxD Active	Hi, Lo	
IR Transmission Delay	Disabled	
UR2 Duplex Mode	Half	
Use IR Pins	IR-Rx2Tx2	
Onboard Parallel Port	378/IRQ7	
Parallel Port Mode	SPP	
EPP Mode Select	EPP1.7	
ECP Mode Use DMA	3	

4.5.4.1 OnChip Primary/Secondary PCI IDE

The integrated peripheral controller contains an IDE interface with support for two IDE channels. Select Enabled to activate each channel separately.

4.5.4.2 IDE Primary/Secondary Master/Slave PIO

These fields allow your system hard disk controller to work faster. Rather than have the BIOS issue a series of commands that transfer to or from the disk drive, PIO (Programmed Input/Output) allows the BIOS to communicate with the controller and CPU directly. The system supports five modes, numbered from 0 (default) to 4, which primarily differ in timing. When Auto is selected, the BIOS will select the best available mode.

4.5.4.3 IDE Primary/Secondary Master/Slave UDMA

These fields allow your system to improve disk I/O throughput to 33Mb/sec with the Ultra DMA/33 feature. The options are Auto and Disabled.

#### 4.5.4.4 IDE HDD Block Mode

This field allows your hard disk controller to use the fast block mode to transfer data to and from your hard disk drive.

#### 4.5.4.5 USB Controller

The options for this field are Enabled and Disabled. By default, this field is set to Enabled.

#### 4.5.4.6 USB 2.0 Controller

The options for this field are Enabled and Disabled. By default, this field is set to Enabled. In order to use USB 2.0, necessary OS drivers must be installed first. Please update your system to Windows 2000 SP4 or Windows XP SP2.

#### 4.5.4.7 USB Keyboard Support

The options for this field are Enabled and Disabled. By default, this field is set to Disabled.

#### 4.5.4.8 USB Mouse Support

The options for this field are Enabled and Disabled. By default, this field is set to Disabled.

#### 4.5.4.9 AC97 Audio

The default setting of the AC97 Audio is Auto.

#### 4.5.4.10 Init Display First

The default setting is PCI Card.

#### 4.5.4.11 Power On After Fail

The setting configures the system power on status when power is restored to the system after a power failure occurrence. The default setting is Off.

#### 4.5.4.12 Onboard FDC Controller

Select Enabled if your system has a floppy disk controller (FDC) installed on the motherboard and you wish to use it. If you install an add-in FDC or the system has no floppy drive, select Disabled in this field. This option allows you to select the onboard FDD port.

#### 4.5.4.13 Onboard Serial/Parallel Port

These fields allow you to select the onboard serial and parallel ports and their addresses. The default values for these ports are:

Serial Port 1	3F8/IRQ4
Serial Port 2	2F8/IRQ3
Parallel Port 3	78H/IRQ7

#### 4.5.4.14 UART Mode Select

This field determines the UART 2 mode in your computer. The default value is Normal. Other options include IrDA and ASKIR.

#### 4.5.4.15 Parallel Port Mode

This field allows you to determine parallel port mode function.

SPP	Standard Printer Port
EPP	Enhanced Parallel Port
ECP	Extended Capabilities Port

#### 4.5.5 Power Management Setup

The Power Management Setup allows you to save energy of your system effectively.

Phoenix - AwardBIOS CMOS Setup Utility  
Power Management Setup

Power-Supply Type	ATX	ITEM HELP
ACPI Function	Enabled	
Power Management	User Define	Menu Level >
Video Off Method	V/H SYNC+Blank	
Video Off In Suspend	Yes	
Suspend Type	Stop Grant	
Modem Use IRQ	3	
Suspend Mode	Disabled	
HDD Power Down	Disabled	
Soft-Off by PWR-BTTN	Instant-Off	
CPU THRM-Throttling	50%	
Wake-Up by PCI Card	Disabled	
Power On by Ring	Disabled	
Resume by Alarm	Disabled	
Date (of Month) Alarm	0	
Time (hh:mm:ss) Alarm	0 : 0 : 0	
** Reload Global Timer Events **		
Primary IDE 0	Enabled	
Primary IDE 1	Enabled	
Secondary IDE 0	Enabled	
Secondary IDE 1	Enabled	
FDD, COM, LPT Port	Enabled	
PCI PIRQ[A-D] #	Enabled	

4.5.5.1 Power Supply Type

Use this field to select the power supply type used in the system. The default setting is ATX.

4.5.5.2 ACPI Function

Enable this function to support ACPI (Advance Configuration and Power Interface).

4.5.5.3 Power Management

This field allows you to select the type of power saving management modes.

There are four selections for Power Management.

Min. Power Saving            Minimum power management

Max. Power Saving            Maximum power management.

User Define    Each of the ranges is from 1 min. to 1hr. Except for HDD Power Down which ranges from 1 min. to 15 min.

4.5.5.4 Video Off Method

This field defines the Video Off features. There are three options.

V/H SYNC + Blank            Default setting, blank the screen and turn off

vertical and horizontal scanning.

DPMS Allows BIOS to control the video display.  
Blank Screen Writes blanks to the video buffer.

#### 4.5.5.5 Video Off In Suspend

When enabled, the video is off in suspend mode. The default setting is Yes.

#### 4.5.5.6 Suspend Type

The default setting for the Suspend Type field is Stop Grant.

#### 4.5.5.7 Modem Use IRQ

This field sets the IRQ used by the Modem. By default, the setting is 3.

#### 4.5.5.8 Suspend Mode

When enabled, and after the set time of system inactivity, all devices except the CPU will be shut off.

#### 4.5.5.9 HDD Power Down

When enabled, and after the set time of system inactivity, the hard disk drive will be powered down while all other devices remain active.

#### 4.5.5.10 Soft-Off by PWRBTN

This field defines the power-off mode when using an ATX power supply. The Instant Off mode allows powering off immediately upon pressing the power button. In the Delay 4 Sec mode, the system powers off when the power button is pressed for more than four seconds or enters the suspend mode when pressed for less than 4 seconds.

#### 4.5.5.11 CPU THRM-Throttling

When the system enters Doze mode, the CPU clock runs only part of the time. You may select the percent of time that the clock runs.

#### 4.5.5.12 Wake up by PCI Card

By default, this field is disabled.

#### 4.5.5.13 Power On by Ring

This field enables or disables the power on of the system through the modem connected to the serial port or LAN.

4.5.5.14 Resume by Alarm

This field enables or disables the resumption of the system operation. When enabled, the user is allowed to set the Date and Time.

4.5.5.15 Reload Global Timer Events

The HDD, FDD, COM, LPT Ports, and PCI PIRQ are I/O events that can prevent the system from entering a power saving mode or can awaken the system from such a mode. When an I/O device wants to gain the attention of the operating system, it signals this by causing an IRQ to occur. When the operating system is ready to respond to the request, it interrupts itself and performs the service.

4.5.6 PNP/PCI Configurations

This option configures the PCI bus system. All PCI bus systems on the system use INT#, thus all installed PCI cards must be set to this value.

Phoenix - AwardBIOS CMOS Setup Utility  
PnP/PCI Configurations

Reset Configuration Data	Disabled	ITEM HELP
Resources Controlled By IRQ Resources	Auto (ESCD) Press Enter	Menu Level
PCI/VGA Palette Snoop	Disabled	Select Yes if you are using a Plug and Play capable operating system Select No if you need the BIOS to configure non-boot devices

4.5.6.1 Reset Configuration Data

This field allows you to determine whether to reset the configuration data or not. The default value is Disabled.

4.5.6.2 Resources Controlled by

This PnP BIOS can configure all of the boot and compatible devices automatically with the use of a use a PnP operating system such as Windows 95.

4.5.6.3 PCI/VGA Palette Snoop

Some non-standard VGA display cards may not show colors properly. This field allows you to set whether or not MPEG ISA/VESA VGA cards can work with PCI/VGA. When this field is enabled, a PCI/VGA can work with an MPEG ISA/VESA

VGA card. When this field is disabled, a PCI/VGA cannot work with an MPEG ISA/VESA card.

#### 4.5.7 PC Health Status

This section shows the parameters in determining the PC Health Status. These parameters include temperatures, fan speeds and voltages.

Phoenix - AwardBIOS CMOS Setup Utility  
PC Health Status

CPU Warning Temperature	85°C	ITEM HELP
Shutdown Temperature	Disabled	Menu Level >
System Temp.	45°C/113°F	
CPU Temp	52°C/125°F	
FAN1 Speed	5400 RPM	
FAN2 Speed	5463 RPM	
FAN3 Speed	5388 RPM	
Vcore(V)	1.02 V	
VGMCH(V)	1.32 V	
+3.3V	3.32 V	
+5V	4.94 V	
+12V	12.03 V	
VBAT	3.21 V	
5VSB(V)	4.96 V	
Smart Fan1 Temp	Disabled	
Smart Fan2 Temp	Disabled	

##### 4.5.7.1 CPU Warning Temperature

This field allows the user to set the temperature so that when the temperature is reached, the system sounds a warning. This function can help prevent damage to the system that is caused by overheating.

##### 4.5.7.2 Temperatures/Voltages

These fields are the parameters of the hardware monitoring function feature of the motherboard. The values are read-only values as monitored by the system and show the PC health status.

##### 4.5.7.3 Shutdown Temperature

This field allows the user to set the temperature by which the system automatically shuts down once the threshold temperature is reached. This function can help prevent damage to the system that is caused by overheating.

##### 4.5.7.4 Smart Fan Temperature

This field enables or disables the smart fan feature. At a certain temperature, the



fan starts turning. Once the temperature drops to a certain level, it stops turning again.

4.5.8 Frequency/Voltage Control

This section shows the user how to configure the processor frequency.

Phoenix - AwardBIOS CMOS Setup Utility		
Frequency/Voltage Control		
Auto Detect PCI Clk	Disabled	ITEM HELP
Spread Spectrum Modulated	Disabled	Menu Level >

4.5.8.1 Auto Detect PCI Clk

This field enables or disables the auto detection of the PCI clock.

4.5.8.2 Spread Spectrum Modulated

This field sets the value of the spread spectrum. The default setting is Disabled. This field is for CE testing use only

4.5.9 Load Fail-Safe Defaults

This option allows you to load the troubleshooting default values permanently stored in the BIOS ROM. These default settings are non-optimal and disable all high-performance features.

4.5.10 Load Optimized Defaults

This option allows you to load the default values to your system configuration. These default settings are optimal and enable all high performance features.

4.5.11 Set Supervisor Password

These two options set the system password. Supervisor Password sets a password that will be used to protect the system and Setup utility. User Password sets a password that will be used exclusively on the system. To specify a password, highlight the type you want and press <Enter>. The Enter Password: message prompts on the screen. Type the password, up to eight characters in length, and press <Enter>. The system confirms your password by asking you to type it again. After setting a password, the screen automatically returns to the main screen.

To disable a password, just press the <Enter> key when you are prompted to enter the password. A message will confirm the password to be disabled. Once the password is disabled, the system will boot and you can enter Setup freely.

#### 4.5.12 Save & Exit Setup

This option allows you to determine whether or not to accept the modifications. If you type “Y”, you will quit the setup utility and save all changes into the CMOS memory. If you type “N”, you will return to Setup utility.

#### 4.5.13 Exit Without Saving

Select this option to exit the Setup utility without saving the changes you have made in this session. Typing “Y” will quit the Setup utility without saving the modifications. Typing “N” will return you to Setup utility.

# CAPTER 5

## Driver Installation

This chapter gives driver installation information to the Panel PC.

Sections include:

- Intel Chipset Software Installation Utility
- VGA Drivers Installation
- AC97 Codec Audio Driver Installation
- Intel PRO LAN Drivers Installation

## Chapter 5 Driver Installation

### 5.1 Intel Chipset Software Installation Utility

The Intel Chipset Drivers should be installed first before the software drivers to enable Plug & Play INF support for Intel chipset components. Follow the instructions below to complete the installation under Windows 98SE/ME/2000/XP.

1. Insert the CD that comes with the board. Click Intel Chipsets and then Intel(R) 855GME Chipset Drivers.



2. Click Intel(R) Chipset Software Installation Utility.
3. When the Welcome screen appears, click Next to continue.

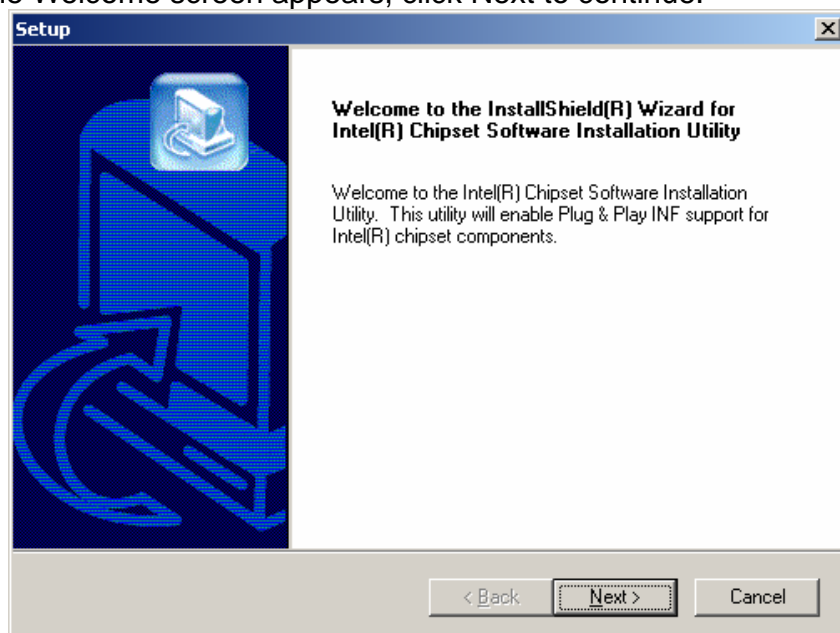

4. Click Yes to accept the software license agreement and proceed with the installation process.



5. On Readme Information screen, click Next to continue the installation.

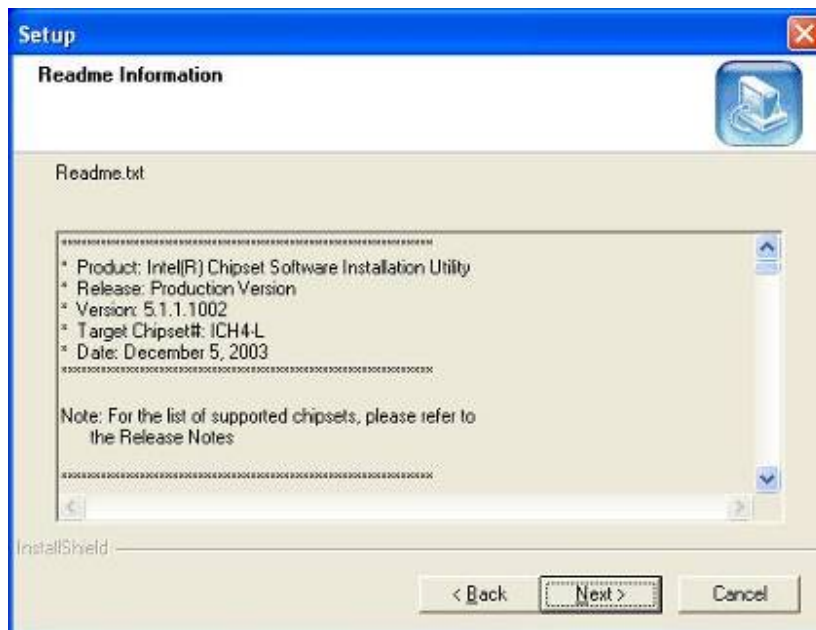

6. The Setup process is now complete. Click Finish to restart the computer and for changes to take effect. When the computer has restarted, the system will be able to find some devices. Restart your computer when prompted.

## 5.2 VGA Drivers Installation

To install the VGA drivers, follow the steps below to proceed with the installation.

1. Insert the CD that comes with the motherboard. Click Intel Chipsets and then Intel(R) 855GME Chipset Drivers.

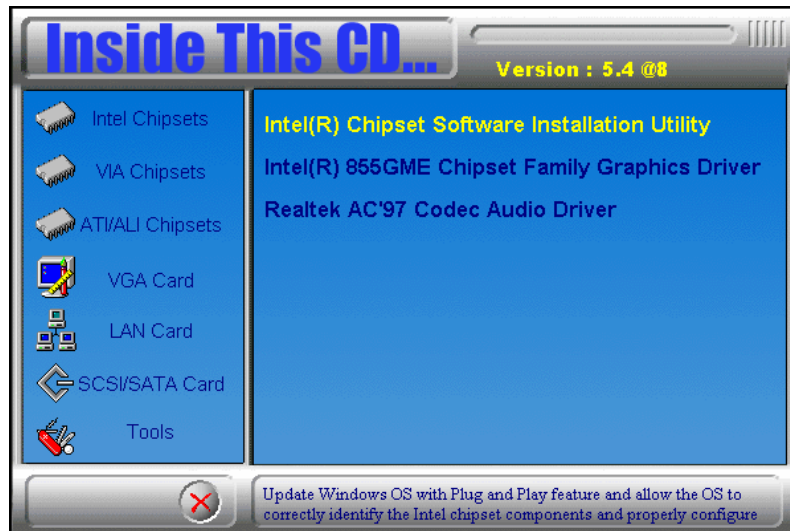

2. Click Intel(R) 855GME Chipset Family Graphics Driver.
3. When the Welcome screen appears, click Next to continue.
4. Click Yes to agree with the license agreement and continue the installation.
5. Restart the computer as prompted and for changes to take effect.

<Attention>

Please update the latest VGA Driver in the User's Manual CD "VGA Driver" program.

### 5.3 AC97 Codec Audio Driver Installation

Follow the steps below to install the Realtek AC97 Codec Audio Drivers.

1. Insert the CD that comes with the motherboard. Click Intel Chipsets and then Intel(R) 855GME Chipset Drivers.
2. Click Realtek AC'97 Codec Audio Driver.



3. Click Finish to restart the computer and for changes to take effect. .

## 5.4 Intel PRO LAN Drivers Installation

Follow the steps below to complete the installation of the Intel PRO LAN drivers.

1. Insert the CD that comes with the motherboard. Click LAN Card and then Intel(R) PRO LAN Drivers.

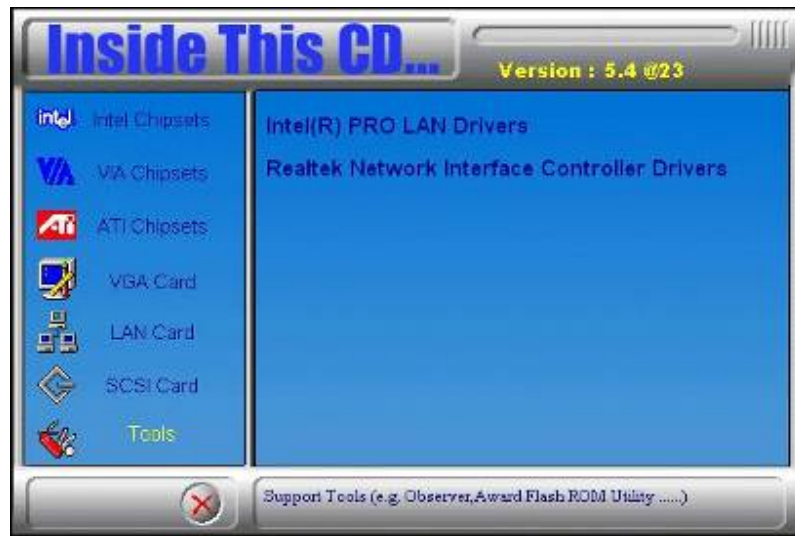

2. Click Install Base Software to continue.



3. When prompted, please to restart the computer for new settings to take effect.



CAPTE  
R  
**6**

## Touch Screen

This chapter gives some information about touch screen solution installed on the Panel PC.

Sections include:

- Introduction
- The AccuTouch Controllers
- Driver Software

## Chapter 6 Touchscreen

### 6.1 Introduction

The PPC supports two Touch Panel Solution- Elo AccuTouch touchscreen and Premier Touch system. Both the two touchscreen system consists of a touchscreen and an electronic touchscreen controller.

The Elo AccuTouch and Premier touchscreen is based on patented resistive technology. The touchscreen may be a flat, spherical, or cylindrical and is installed over the face of the display. Since its shape matches that of the display face, the touchscreen has excellent clarity and minimal parallax.

### 6.2 The Elo AccuTouch Driver Installation

Elo AccuTouch driver software provides a consistent software interface among all Elo touchscreens and controllers. Go to [www.elotouch.com/Support/dnld.asp](http://www.elotouch.com/Support/dnld.asp) for a complete list of available drivers.

For Driver Installation, please install the “Elo TouchSystem TouchTools CD” for Windows XP, Windows 2000, Windows Me, Windows 98, Windows 95, Windows NT, Windows CE 2.x, 3.0, 4.x, Windows XP Embedded, Windows 3.1, DOS, OS/2 Warp, and Apple Macintosh. Just follow the step by step to install the driver.



### 6.2.1 Configuration Utility

After finishing the installation, please follow the steps to test the configuration utility.

(1) Enter “My Computer”, click the “Elo touchscreen” shortcut function.

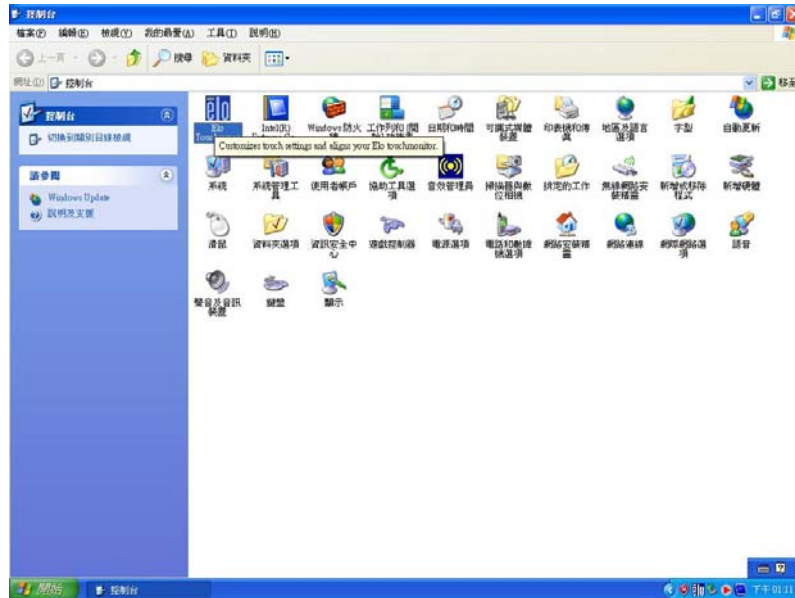

(2) Click “Align” function key to go to next step.

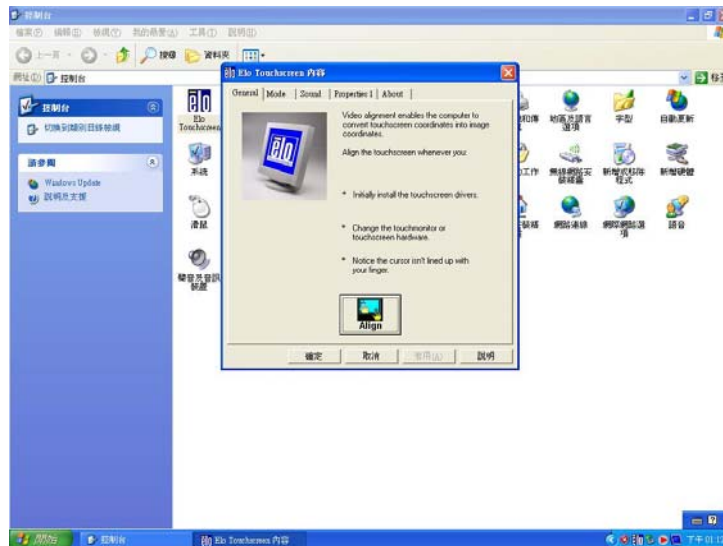

(3) Correct 4 point locations on screen with the Panel. Screen display as follows.

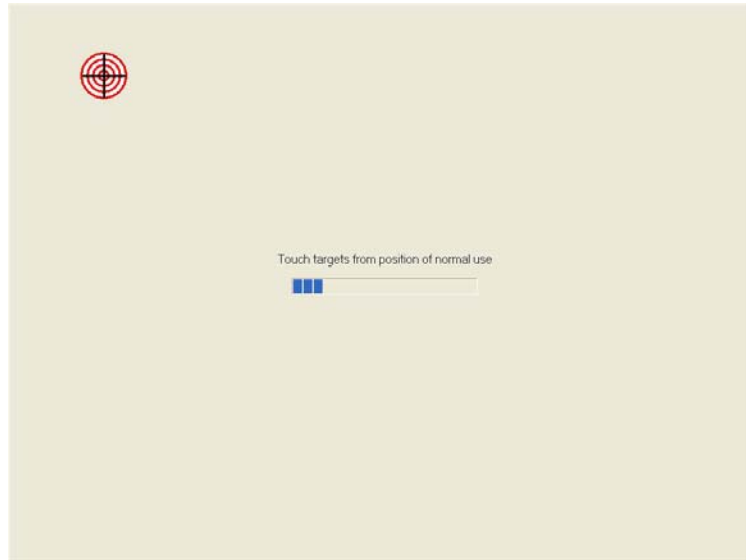

(4) Touch the "yes" function if the cursor follows your finger and finish the utility test.

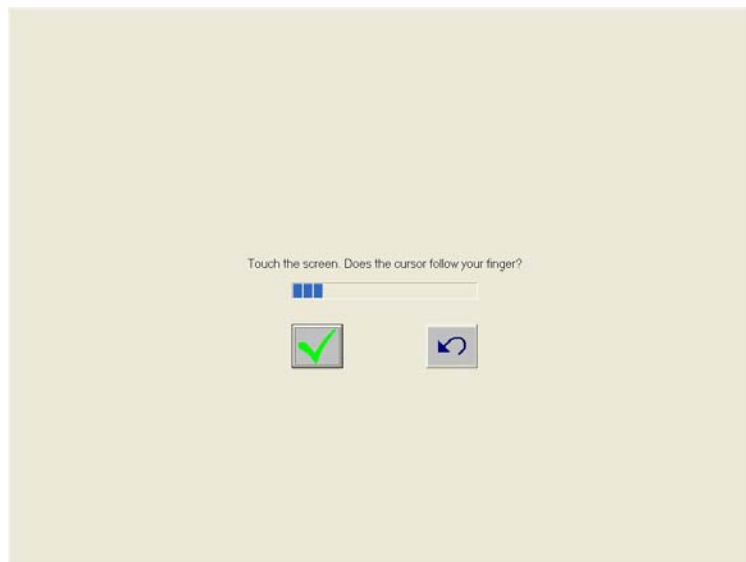

### 6.3 The Premier Touch Driver Installation

*TouchKit* is the Premier Touch software, which contains drivers of the touch panel controllers for the specified communication connectors, RS232, PS/2 and USB, and the other two utilities.

The two utilities are as follows:

(1) Touch Tray support

This is utility for emulating the right and left button of mouse through controlling touch panel. Users can toggle between right or left mouse buttons by this utility.

(2) Configuration support

The calibration and draw test of touch panel are done by this utility. Besides, users can add or remove for new RS-232 or PS/2 touch panel devices.

Follow these steps to install *TouchKit*.

(1) Put the *TouchKit* CD to CD-ROM.

(2) Open the Win2000\_XP directory.

(3) Double click the Setup.exe, then windows starts to run the installation program.  
Notice that do not plug the USB controller on the system before the installation has been finished.

(4) Just click [Next >] button to continue installation.



(5) Following the step by step to finish the driver installation.

### 6.3.1 Configuration Utility

After finishing the installation, please follow the steps to test the configuration utility.

(1) Click the “TouchKit” shortcut function in the desktop.



(2) Enter “General” function and choose the language you need. Then go to next step.

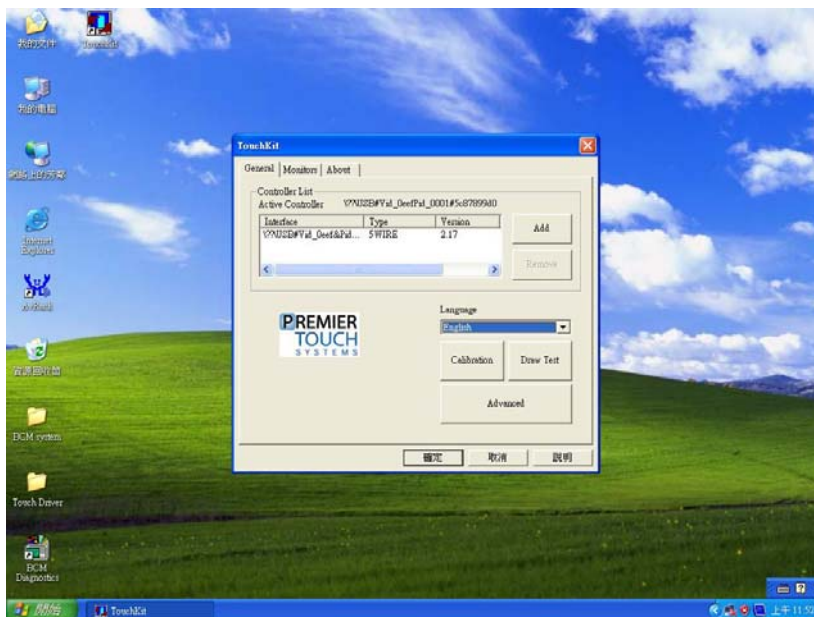

(3) Correct 4 point locations on screen with the Panel. Screen display as follows



(4) Play “yes” to continue if 4 points calibration test is fine and finish the test.

